





TABLE OF CONTENTS

Applications	3
Fan-coil Models	4
Design Features	5
Floor Models	6-7
Ceiling Models	8
Physical Data	9
Ratings	10
Selection Examples	11-16
Roughing in Dimensions	17-23
Engineering Specification	24

NOTE:

All specifications & dimensions subject to change without notice.

SARAVEL Fan-coil unit are intended for individually controlled room air conditioning in buildings.

Fan- Coils are used in hotels, office-buildings and residential complexes, wherein a central plant supplies chilled and hot water for cooling and heating.

Main Features:

- 1- Heavy sheet metal, rugged construction.
- 2- Long life of critical items.
- 3- Quiet operation- whisper quiet on low speed.
- 4- Ease of installation and maintenance.
- 5- Decorative enclosures.
- 6- High performance.

SARAVEL Fan-Coil units are designed for visual elegance and long life. The enclosure construction is of 1.25 mm thick steel sheet, rust proofed and phosphate with baked enamel coating.

The panel is insulated with 10 mm thick, polyethylene insulation. Special attention is given to the selection of motors and fans for long life ease of maintenance, and quiet operation.

A three speed rotary manual switch controls the operation of the fan with automatic high speed start to protect the motor.

STANDARD FEATURES

Construction

All Units

- SARAVEL certified and labeled
- Galvanized steel construction
- 1/2" thick insulation
- Integral filter rack with 1" throwaway filter
- Integral rear ducted return - field reversible to bottom return

Exposed units

- Stamped louver supply and return air grilles
- Durable powder coat paint

Coils

- Cooling and heating - 3 row chilled water
- 3/8" O.D. seamless copper tubes
- 0.012" tube wall thickness
- High efficiency aluminum fin surface for optimizing heat transfer, pressure drop and carryover

- Access to entering and leaving air sides for cleaning
- Removable for service
- Manual air vents

Drain Pans

- Single wall, galvanized steel, externally insulated antimicrobial
- Positively sloped to drain connection
- Removable, field reversible
- 5/8" O.D. primary drain connection

Fan Assemblies

- Forwardly curved, DWDI centrifugal type
- 220 volt, single phase, three tap PSC motors
- Quick disconnect motor connections
- Removable fan/motor deck for service

Electrical

- Electrical junction box for field wiring terminations
- Terminal block for field connections

NOMENCLATURE

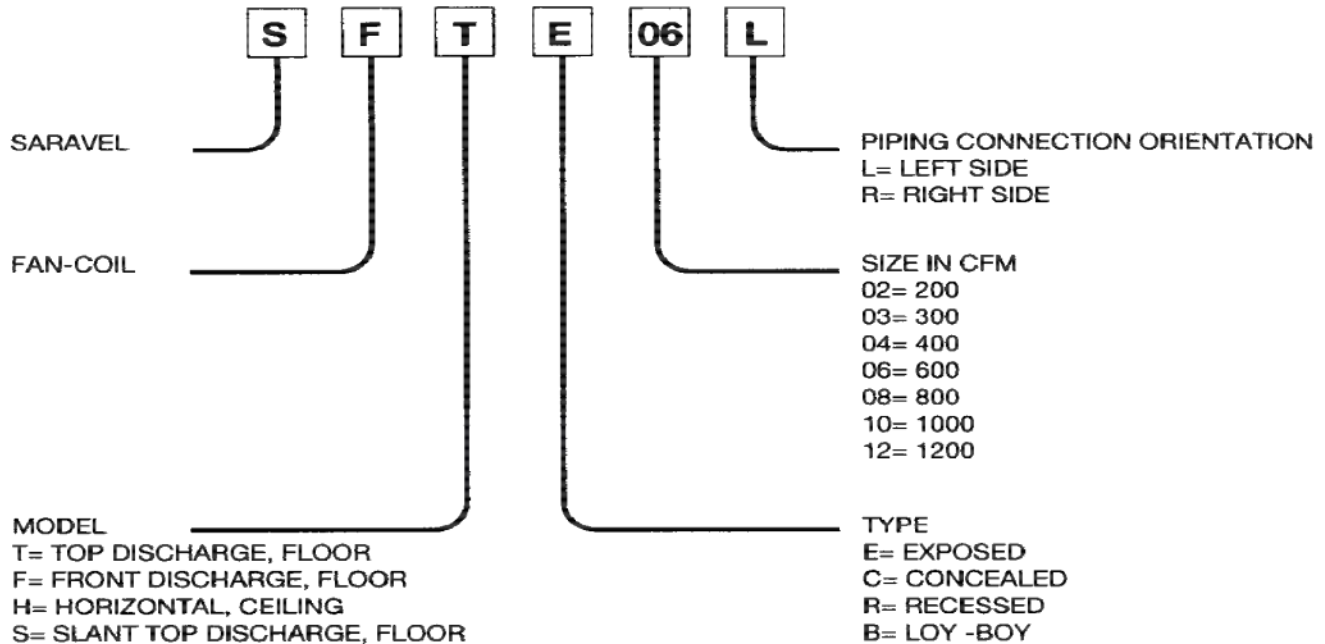

FAN-COIL MODELS

SARAVEL offers the following fan-coil models, in the range of 200 to 1200 CFM.

1- Top Discharge Floor Models

- A. Top Discharge Exposed
- B. Slant Top Discharge Exposed

TE
SE



2- Front Discharge Floor Models

- A. Front Discharge Exposed
- B. Front Discharge Concealed

FE
FC



3- Lo-Boy

TB

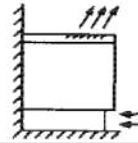

4- Ceiling Horizontal Models

- A. Ceiling Horizontal Exposed
- B. Ceiling Horizontal Concealed

HE
HC

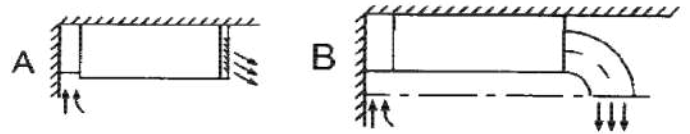

- 1- Fan
- 2- Coil
- 3- Filter
- 4- Air flow Outlet
- 5- Drain Pan
- 6- Air Vent
- 7- Water Inlet
- 8- Motor
- 9- Speed Control Switch

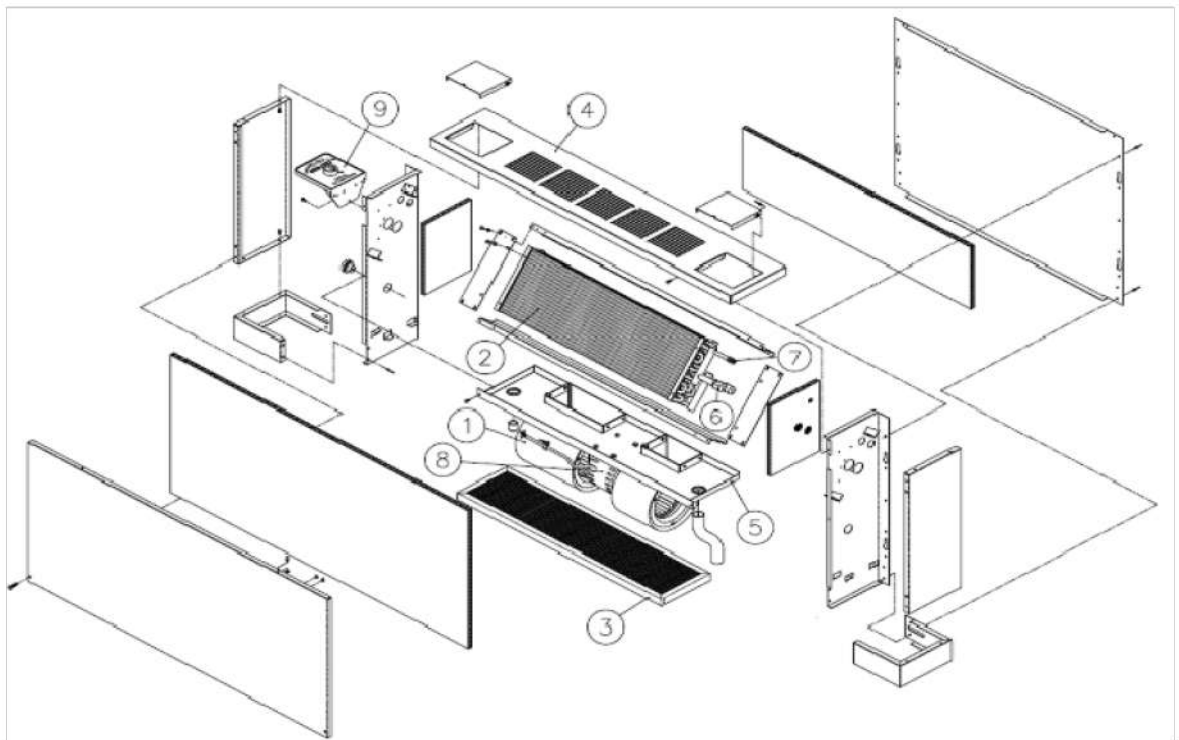



DESIGN FEATURES

5

- Heavy gauge (1.2mm) steel cabinet decoratively designed, with top priority given to the ease of Installation and maintenance.
- Rust proofed phosphate enclosure with baked enamel finish.
- Insulated front panel to prevent the transmission of sound vibration and moisture formation.
- Use of insulation and high quality motor and fan, for quiet operation.
- Rust-proof heavy gauge galvanized sheet metal for condensate drip pan.
- High performing rugged coil is slanted to assure proper condensate removal.
- Fresh air damper and opening are optional items on SARAVEL fan-coil units.
- Special winding for motors provides high performance at all three speeds. The low speed selected for noise-free, sleep-inducing operation.
- Use of three speed motor with automatic start at high speed to protect motor on stat-up.
- Easily removable, washable filter.
- Condensate drip pan in also the motor-fan deck. Condensate drip pan easily slides out.
- Fan switch, and all piping connections could quickly and easily be located to the right or left side.
- Three speed manual fan switch with an "off" position for easy speed selection.



FLOOR MODELS

TOP DISCHARGE FLOOR UNITS ARE DESIGNED EITHER AS EXPOSED OR RECESSED MODELS.

Top Discharge Exposed Unit, TE

The model TE, exposed floor unit is furnished in decorative attractive colors to match most interior decors. The one piece front panel is readily removable, allowing fast and complete access to the coil, fans, motor, speed control switch, electrical wiring, and fresh air damper. The fan-deck slides out easily for maintenance. The cleanable filter can be re- moved and washed without removing the front panel.



Top Discharge Exposed Unit, SE

The model SE, exposed floor unit with a slanted top, has an attractively styled cabinet, designed for application in schools, institutions, hospitals and public buildings, where it is likely that books and other items would be placed over the discharge grills of a flat-top design.



Lo-Boy, TB

The model TB, top discharge exposed Lo-Boy unit is a top discharge low silhouette unit.

The basic components and the front panel arrangements are the same as the top discharge units.



FRONT DISCHARGE FLOOR UNITS ARE DESIGNED AS EXPOSED, CONCEALED OR RECESSED MODELS.

Front Discharge Exposed Unit, FE

The model FE, front discharge exposed floor unit is basically the same as model TE, except that the discharge louver is located in the front.



Front Discharge Concealed Unit, FC

The model FC, front discharge floor unit is a concealed unit with a decorative front panel. The front panel could then be mounted on to a frame work supplied by others.





CEILING MODELS

CEILING MODELS ARE HORIZONTAL UNITS, DESIGNED AS EXPOSED OR CONCEALED MODELS.

Ceiling Horizontal Exposed Model, HE

The model HE, horizontal exposed unit is built for suspension from ceilings in new or existing buildings.

All the components except the drain pan is the same as model TE. The unit is furnished with an easily removable bottom panel. Opening the bottom panel exposes all the components for maintenance and service.



Ceiling Horizontal Concealed Model, HC

The model HC is designed for concealed ceiling applications. The main body is concealed and the only bottom panel is visible.

The bottom panel extends beyond the side panels. The conditioned air connection is located in front of the unit. A duct and a grill, supplied by others, can deliver the conditioned air in any mode the customer desires.



Optional HC Model

The optional HC model is ideal for applications where the false ceiling has low head room and extended drain pan is required for condensate drainage.

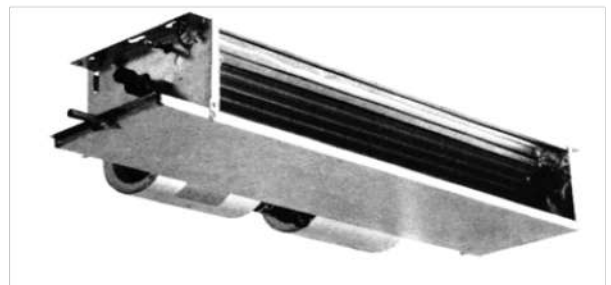



PHYSICAL DATA

TABLE 1. PHYSICAL DATA

UNIT SIZE		SF-02	SF-03	SF-04	SF-06	SF-08	SF-10	SF-12
COIL *	Face Area (sq. ft.)	0.9	1.4	1.6	1.9	2.4	3.1	3/8
	Size, Connection (inches)	1/2	1/2	1/2	3/4	3/4	3/4	3/4
	Water Capacity (liters)	1.5	2.1	2.4	2.8	3.6	5	5.6
FAN	Number of fans	1	2	2	2	3	4	4
	Wheel diameter (inches)	5 ^{3/4}	5 ^{3/4}	5 ^{3/4}	5 ^{3/4}	5 ^{3/4}	5 ^{3/4}	5 ^{3/4}
	Wheel width (inches)	7	7&4	7	9	7	7&9	9
	Total Fan Outlet Area (sq. ft.)	0.2	0.3	0.4	0.5	0.6	0.8	1.0
	Tip speed (ft/min.)	1.5XRPM	1.5XRPM	1.5XRPM	1.5XRPM	1.5XRPM	1.5XRPM	1.5XRPM
MOTOR	Number of Motors	1	1	1	1	2	2	2
	Nominal Motor HP	1/30	1/25	1/25	1/20	1/20-1/30	1/20	1/20
	Total Name Plate Amps	0.2	0.24	0.24	0.3	0.5	0.6	0.6
	Nominal RPM, Approx.							
	High Speed	1285	1285	1285	1285	1285	1285	1285
	Medium Speed	1000	1000	1000	1000	1000	1000	1000
	Low Speed	700	700	700	700	700	700	700
	Approximate Power (Watts)							
	High Speed	37	41	45	49	86	94	98
Medium Speed	34	32	36	48	82	85	96	
Low Speed	23	23	26	40	63	64	80	

Note: Motors electrical characteristics are 220V, 1PH, 50 Cycles.
 * 3 Row

TABLE 2. NOMINAL COOLING AND HEATING CAPACITY

UNIT SIZE	AIR FLOW CFM	WATER FLOW – GPM		NET COOLING CAP. – BTU/hr		NET HEATING CAP. – BTU/hr
		COOLING	HEATING	TOTAL	SENSIBLE	
SF-02	200	1.6	2.1	7,800	5,300	20,100
SF-03	300	2.5	3.1	12,400	8,300	30,300
SF-04	400	3.2	4.1	16,100	10,800	39,500
SF-06	600	4.4	5.8	21,900	15,000	56,000
SF-08	800	6.0	7.7	30,000	20,300	74,700
SF-10	1000	7.5	9.6	37,500	25,300	93,500
SF-12	1200	9.5	11.8	47,400	31,600	114,600

TABLE 3. FAN COIL UNIT WEIGHTS (kg)

MODEL	TYPE (TE-SE) – FC - FE	HE - HC
200	31	22
300	37	28
400	40	32
600	47	36
800	57	47
1000	71	56
1200	82	-

1. Cooling ratings are based on ARI Standard 410-91. Entering air at 80°F dry bulb and 67°F wet bulb temperatures, entering water temperature at 45°F, and leaving water temperature at 55°F.

2. Heating ratings are based on ARI Standard 410-91. Entering air temperature at dry bulb temperature of 70°F ; entering water temperature at 180°F and leaving water temperature at 160°F.



RATINGS

It is our goal to give the designer a complete knowledge of SARAVEL Fan-Coil Units. The performance of the fan-coil is the most important factor. TABLE 2 shows the ratings for each fan-coil size. The fan-coil ratings for other conditions are presented in the following discussions.

In the fan-coil, the energy delivered by water is gross capacity. For cooling, the net fan-coil output is the gross capacity minus the heat input by the fan motor. For heating the net fan-coil capacity is the gross heating capacity plus the fan motor heat. TABLE 4 shows the approximate heat generated by the motor-fans for different size at different speeds. In all cases, the ratio of heat generated by the motor- fan to the total heat output is less than 3 percent. Several diagrams are presented in the following pages to help the designer in selection of fan-coil units.

There are basically two types of ratings presented:

- The wet cooling rating where the sensible heat factor

$$\frac{\text{Sensible heat}}{\text{Total heat}} \text{ is less than } 0.91$$

- The dry cooling rating where the sensible heat factor is greater or equal to 0.91. The dry rating diagrams are also used for heating.

In addition, the gravity heating charts and the coils pressure drops are also given. The following examples illustrate the application and the use of these charts.

Each example demonstrates an approach to the use of rating data, but the designer can use the rating data in many ways to find the desired information.

I. WET RATINGS (COOLING AND DEHUMIDIFICATION)

The wet ratings are used where the unit is to be selected to remove the sensible and latent heat, when the ratio of sensible to total capacity (sensible heat factor) is less than 0.91. Otherwise, the dry ratings should be employed.

SELECTION PROCEDURE

In general we want to select a fan-coil to cool and heat a room and usually the cooling capacity dictates the choice. Normally the following room cooling capacities and temperature conditions are given, and we want to select the fan-coil and determine the water flow.

- A) Total cooling capacity-BTU/hr.
- B) Sensible cooling capacity-BTU/hr.
- C) Room wet bulb and dry bulb temperatures.

TABLE 4. APPROXIMATE VALUES OF HEAT RELEASE BY THE MOTOR – FAN, BTU/hr.

SPEED	UNIT SIZE						
	SF-02	SF-03	SF-04	SF-06	SF-08	SF-10	SF-12
HIGH	188	274	383	513	700	782	1,026
MEDIUM	150	222	274	427	578	700	855
LOW	140	192	205	376	516	615	752

TABLE 5. OPERATING FACTOR (O.F.)

TA	TW										
	40	41	42	43	44	45	46	47	48	49	50
60	0.84	0.80	0.76	0.72	0.68	0.64	0.59	0.55	0.51	0.47	0.43
61	0.89	0.85	0.81	0.77	0.73	0.69	0.65	0.61	0.56	0.52	0.48
62	0.94	0.90	0.86	0.82	0.78	0.74	0.70	0.66	0.62	0.58	0.53
63	1.00	0.96	0.91	0.87	0.83	0.79	0.75	0.71	0.67	0.63	0.59
64	1.05	1.01	0.97	0.93	0.88	0.84	0.80	0.76	0.72	0.68	0.64
65	1.10	1.06	1.02	0.98	0.94	0.90	0.85	0.81	0.77	0.73	0.69
66	1.15	1.11	1.07	1.03	0.99	0.95	0.91	0.87	0.82	0.78	0.74
67	1.20	1.16	1.12	1.08	1.04	1.00	0.96	0.92	0.88	0.84	0.79
68	1.26	1.22	1.17	1.13	1.09	1.05	1.01	0.97	0.93	0.89	0.85
69	1.31	1.27	1.23	1.19	1.14	1.10	1.06	1.02	0.98	0.94	0.90
70	1.36	1.32	1.28	1.24	1.20	1.16	1.11	1.07	1.03	0.99	0.95

TA = Entering air wet bulb temperature °F.
 TW = Entering water temperature °F.



SELECTION EXAMPLES

As will be shown in the following examples, we use the total capacity, room and water temperatures to select a fan-coil and determine the water flow. Then we will check the sensible heat performance of the fan-coil to see how it compares with the required sensible heat capacity. The selection procedure is outlined in the following examples:

Given:

- A) Total cooling load of 19,400 BTU/hr.
- B) Sensible cooling load of 16,500 BTU/hr.
- C) Entering air temperature 79°F db/64°F wb.
- D) Entering water temperature 46°F.

Find:

The fan-coil size and the water flow rate.

1. Fan-Coil size

TABLE 2 presents the nominal rating for the SARAVEL Fan-Coils. For any other condition the rating is modified by an operating factor.

A - Operating factor is found from TABLE 5 as a function of entering air wet bulb (TA) temperature, and entering water temperature (TW). For TA = 64°F, and TW = 46°F, the operating factor is equal to 0.8.

Note: Operating factor can also be determined from the equation:

$$\text{O.F.} = \frac{52(\text{TA}) - 41(\text{TW}) - 640}{1000}$$

The operating factor is used to determine the equivalent rating, sensible and total cooling capacities in 'wet' condition.

B - Equivalent cooling load, for this operating factor is:

$$\frac{19,400}{0.8} = 24,250 \text{ BTU/hr}$$

C - Using the equivalent rating, and TABLE 2, we find out that SF-08 satisfies the load.

2. Water Flow Rate in GPM

The water flow rate is determined from FIGURE 1, which gives the total cooling capacity as a function of water flow rate (GPM) with the operating factor (OF) and the unit size as parameters.

To find the water flow rate in GPM, enter this plot on the left at the given total cooling load (19,400). From this point, project a horizontal line to the right, as

shown by the dotted line, until this line intersects the predetermined operating factor (0.8). From this intersection extend a vertical line downward, intersecting the given unit size (SF-08). From this point proceed horizontally to the right until this line intersects the water flow rate (GPM) axis and read the result (5 GPM).

Note 1: If it is required to operate the fan-coil unit at medium or low fan speed, the capacity multiplying factor, (FIGURE 1) for the fan speed should be applied before the above procedure is followed. Namely, the given total cooling capacity should be divided by the capacity multiplying factor, resulting in a higher initial cooling capacity. Then, using the corrected total cooling capacity follow the procedure outlined above.

Note 2: If the unit size, entering water temperature (TW), entering air wet bulb temperature (TA), and the water flow rate (GPM) are given and the total cooling capacity is required, then this plot can be used in reverse according to the procedure previously outlined.

Note 3: If unit size, entering air wet bulb temperature, desired total cooling capacity and the water flow rate are given and the entering water temperature is to be determined: this plot can be used to determine the operating factor and then from TABLE 5, using the operating factor and the given entering air wet bulb temperature, the entering water temperature can be found.

Note 4: To find the water temperature difference between the inlet and outlet.

$$\Delta T(^{\circ}\text{F}) = \frac{\text{TOTAL BTU/hr}}{500 \times \text{GPM}}$$

This equation is valid for both the gross cooling and the heating capacities.

3. SENSIBLE COOLING CAPACITY

The following procedure is used to find the actual sensible cooling capacity delivered by the fan-coil.

• OPERATING FACTOR

Similar to part 1-A, the operating factor is found from TABLE 5, as a function of entering air wet bulb temperature (TA) and entering water temperature (TW). For TA = 64°F and TW = 46°F, the operating factor is 0.80. As mentioned before, the sensible cooling capacity operating factor is the same as the total cooling capacity operating factor for the same entering conditions, namely; entering air wet bulb temperature, and entering water temperature.



SELECTION EXAMPLES

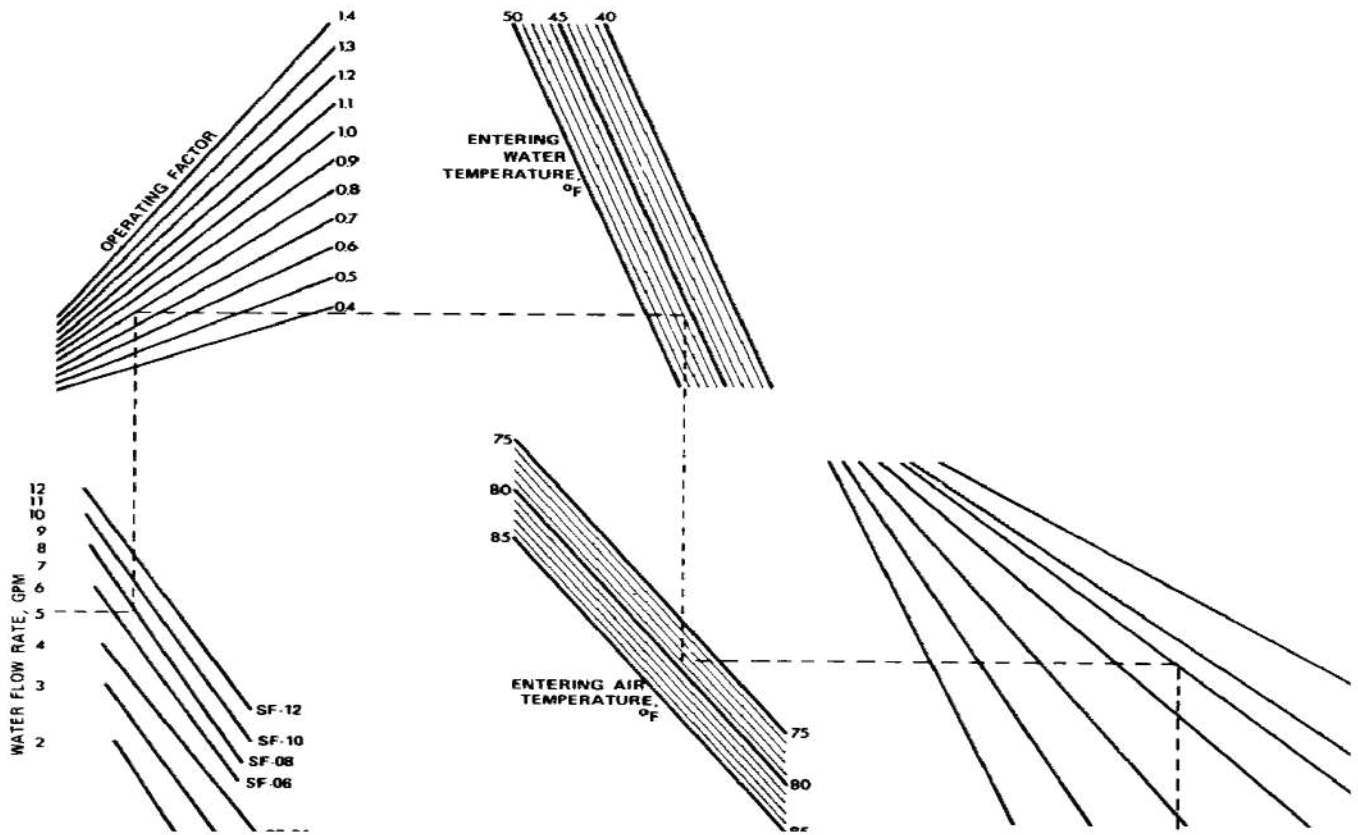

FIGURE 1. WET TARING SENSIBLE COOLING CAPACITY

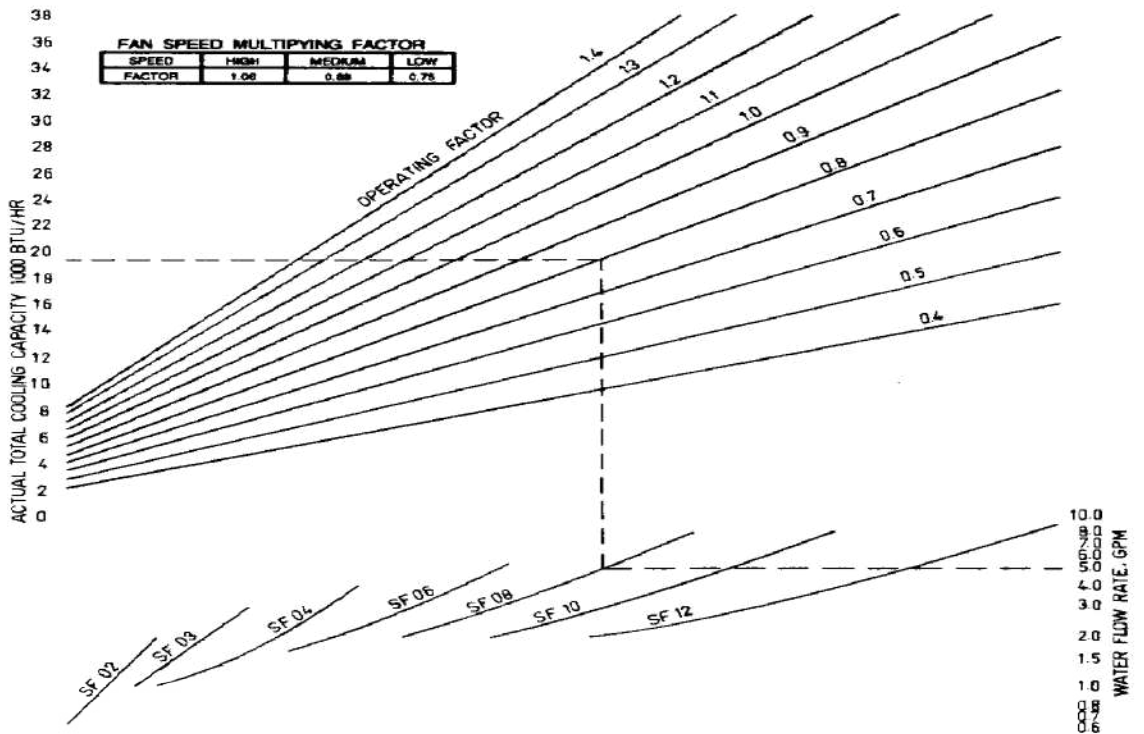

FIGURE 2. WET AIR DEHUMIDIFICATION



SELECTION EXAMPLES

• SENSIBLE COOLING CAPACITY

FIGURE 2 is used to find the sensible cooling capacity as a function of water flow rate (GPM), the operating factor (OF), unit size, entering air dry bulb temperature and entering water temperature.

To determine the sensible cooling load capacity, enter this plot at the given water flow rate (5 GPM) and proceed to the right until this line intersects the given unit size (SF-08) as shown by the dotted line. From this point project a straight vertical line upward crossing the predetermined operating factor line (0.8), then extend a horizontal line to the right until this line intersects the given entering water temperature line (46°F). From this point proceed vertically downward until this line intersects the given entering air temperature (79°F).

Then proceed horizontal until this line intersects the unit size line (SF-08).

Finally project a straight vertical line downward until this line intersects the sensible cooling capacity axis and read the sensible cooling capacity (16,900 BTU/hr)

Note 1: If sensible cooling capacity, with medium or low fan speed is desired, apply the capacity multiplying factor for fan speed (FIGURE 1).

Note 2: If unit size, entering water temperature, entering air wet and dry bulb temperatures, and desired sensible cooling capacity are given and the water flow rate in GPM is required, this plot can be used in reverse of the procedure stated above.

• CHECK ON VALIDITY OF THE WET RATINGS

As stated above, the wet ratings are valid only if the ratio of sensible to total capacity (sensible heat factor) is less than 0.91. For example, the sensible heat factor is:

$$\text{S.H.F.} = \frac{16,900 \text{ BTU/hr}}{1,400 \text{ BTU/hr}} = 0.87$$

Therefore, the wet ratings are valid. Since the actual delivered sensible cooling is within a reasonable range of the required sensible cooling load, the selected fan-coil unit, SF-08 at high fan speed will meet the required cooling load.

II. DRY RATING (SENSIBLE COOLING OR HEATING CAPACITY)

The dry ratings are used when the unit is to be selected to supply the sensible heating or cooling.

The method should be used when the ratio of sensible to total cooling capacity (sensible heat factor) is greater than 0.91, otherwise the wet ratings should be employed.

SELECTION PROCEDURE

The selection procedure is demonstrated in the following example:

Given:

- A) SF-06 unit at high fan speed.
- B) Heating capacity = 40,000 BTU/hr.
- C) Entering water temperature = 170°F.
- D) Entering air dry bulb temperature = 70°F.

WATER FLOW RATE

The flow rate, in GPM, is determined from FIGURE 3.

The temperature difference for heating capacity is equal to the entering water temperature (170°F) minus the entering air dry bulb temperature (70°F). For cooling, the temperature difference is equal to entering air dry bulb temperature minus the entering water temperature.

Temperature difference = 170 – 70 = 100°F to find the water flow rate in GPM, enter FIGURE 3 on the left at the given heating load 40,000 BTU/hr. From this point project a straight horizontal line, until this line intersects the predetermined temperature difference line (100°F). From this intersection extend a vertical line downward intersecting the given unit size (SF-06). From this point proceed horizontally to the right until this line intersects the water flow rate (GPM) axis, and read 2.80 GPM.

Note: If it is required to operate the fan-coil unit at medium or low fan speed, the capacity multiplying factor for the fan speed, as given in FIGURE 1, should be applied before the above procedure is followed. Namely, the given heating capacity should be divided by the capacity multiplying factor, resulting in a higher initial heating capacity. Using the corrected heating capacity, the procedure stated above should be followed.

SELECTION EXAMPLES

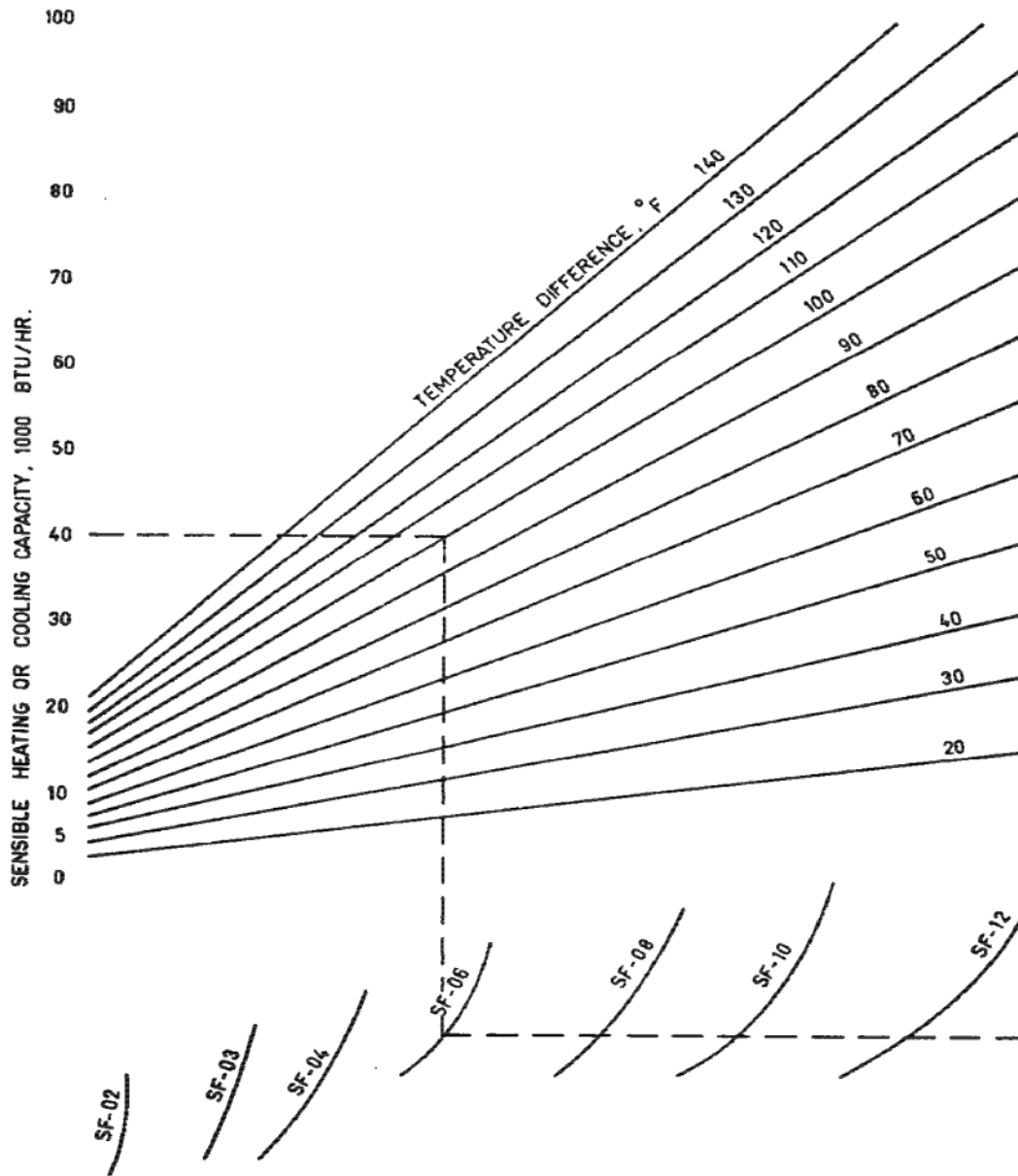

FIGURE 3. DRY RATINGS SENSIBLE COOLING AND HEATING CAPACITY

III. GRAVITY HEATING RATINGS

The gravity heating ratings are used only when it is required to know the amount of heat that is supplied by the fan-coil unit when the fans are turned off. The following example explains the procedure.

Given:

- A) SF-08 unit with fans turned off
- B) Water flow rate = 5 GPM
- C) Entering Water temperature = 170°F
- D) Entering air dry bulb temperature = 70°F

Find:

The gravity heating capacity

The gravity heating is determined from FIGURE 4 which gives the gravity heating capacity as a function of water flow rate with the temperature difference and the unit size as parameters.

The temperature difference for gravity heating is the same as for heating; namely, it is equal to the entering water temperature (170°F) minus the entering air dry bulb temperature (70°F).



SELECTION EXAMPLES

The temperature difference for this example is equal to 100°F.

To find the gravity heating capacity, enter FIGURE 4 on the right at the given water flow rate (5 GPM) and proceed horizontally to the left until this line intersects the given unit size line (SF-08). Then extend a vertical line upward until this line intersects the predetermined temperature difference line (100°F). Finally project a horizontal line to the left until this line intersects the gravity heating capacity axis and read the result: 1640 BTU/hr.

Note: If the unit size, entering water temperature, entering air dry bulb temperature and the desired gravity heating capacity are given and the water flow rate in GPM is required, this plot can be used in reverse.

IV. WATER PRESSURE DROP

FIGURE 5 gives the pressure drop thru the coils. The procedure is outlined in the following example:

Given:

- A) SF-08
- B) Water flow rate = 5GPM

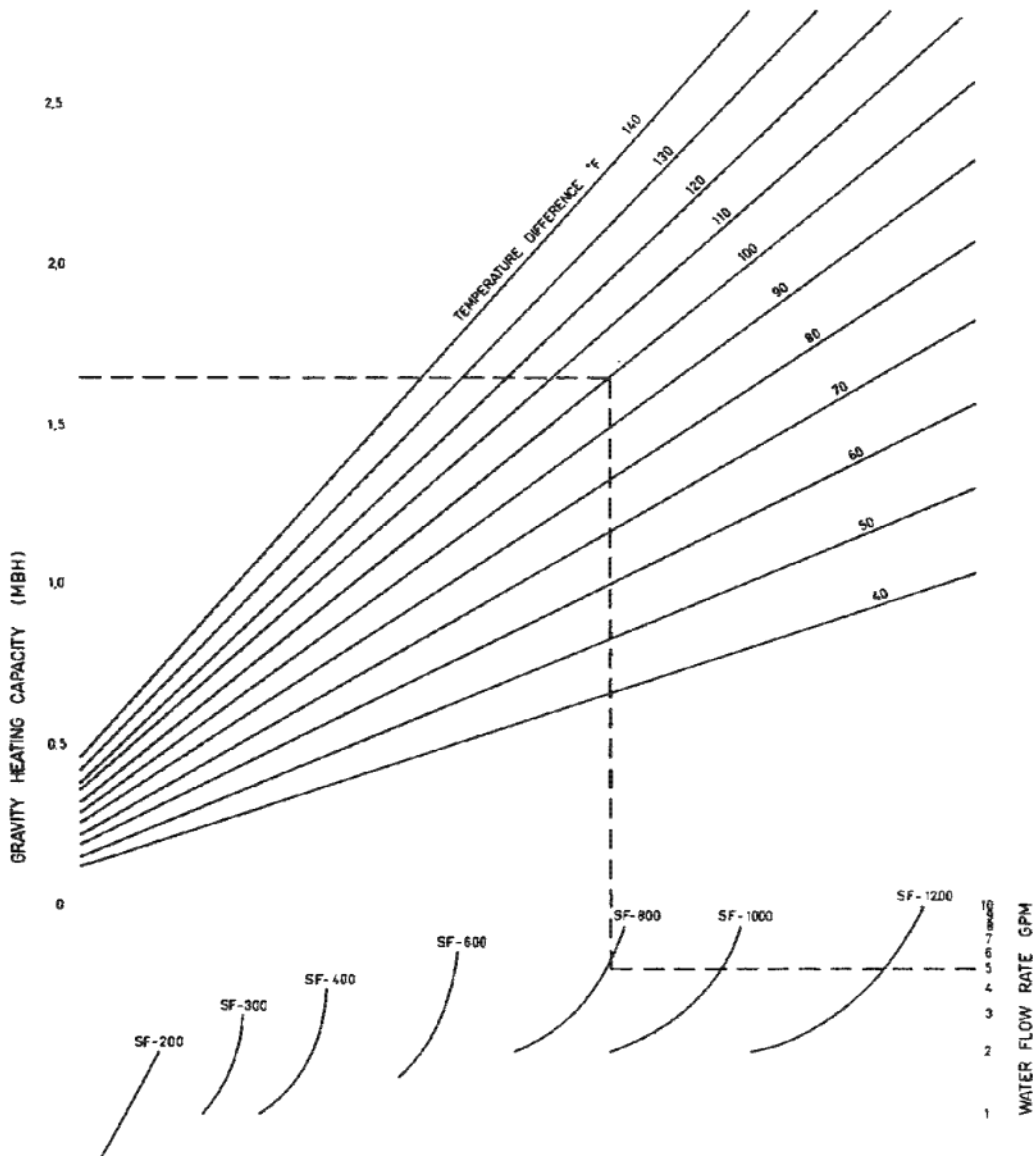



SELECTION EXAMPLES

Find:

Water pressure drop in feet of water

To determine the water pressure drop thru coil in feet of water, enter FIGURE 5 on the left at the given water flow rate (5 GPM). From this point project a horizontal line to the right (as shown by the dotted line) until this line intersects the given unit size (SF-08). From this point extend a vertical line downward until this line intersects the pressure drop axis and read the result (9.5 ft. of water).

V. STANDARD RATINGS

Standard ratings for SARAVEL fan-coil units are given in TABLE 2.

1. Ratings for cooling are based on the following conditions:

- A - Unit at high fan speed
- B - Entering air dry bulb temperature = 80°F
- C - Entering air wet bulb temperature = 67°F

D - Entering water temperature = 45°F

E - Leaving water temperature = 55°F

2. Ratings for heating are based on the following conditions:

- A - Unit at high fan speed
- B - Entering air dry bulb temperature = 70°F
- C - Entering water temperature = 180°F
- D - Leaving water temperature = 160°F

VI. NOISE

Extreme care has been taken in the selection and design of fan, motor and the insulation of the enclosure to ensure quiet operation.

Noise measurements based on NEBB and ARI 350-86 standard have revealed SARAVEL units to operate well within international noise limit standards for indoor air conditioning units.

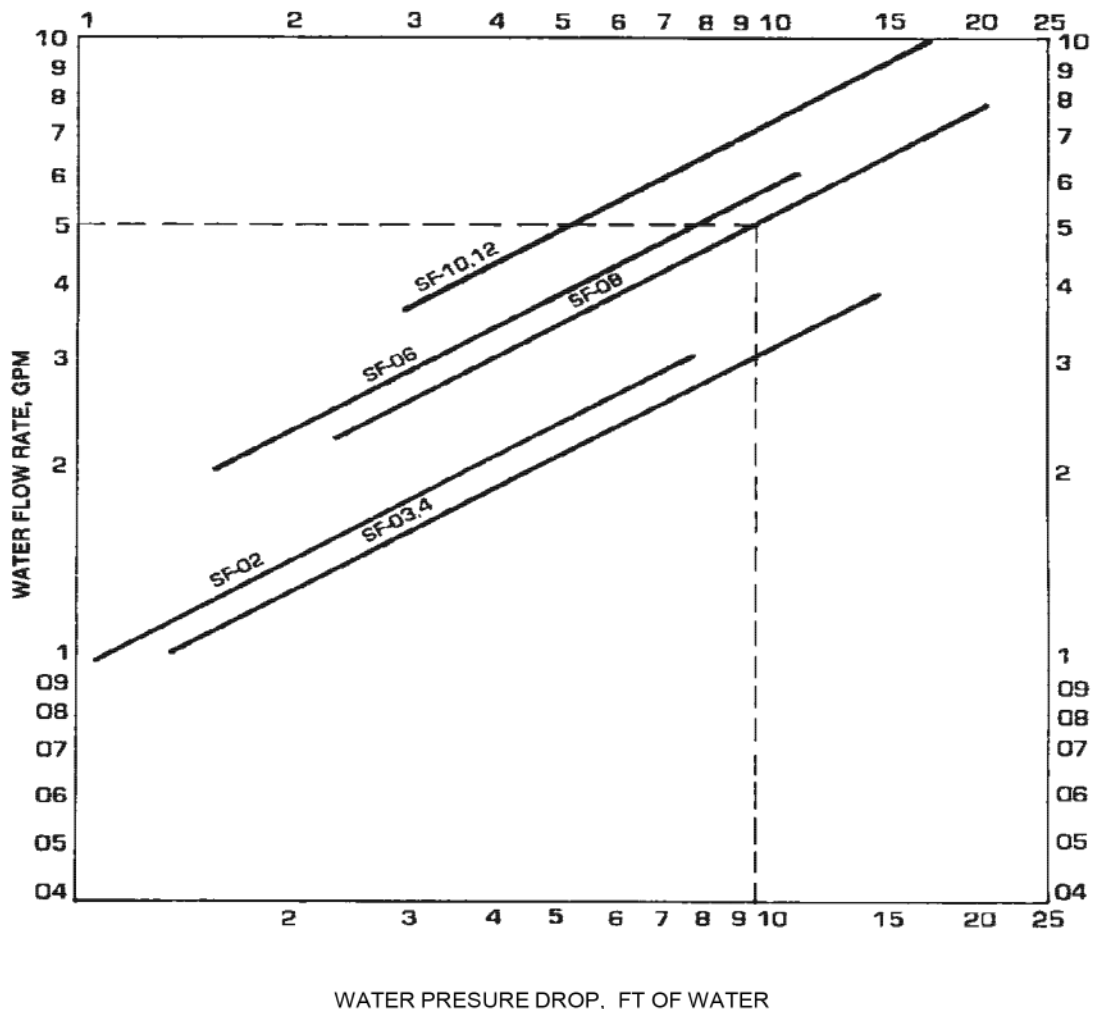
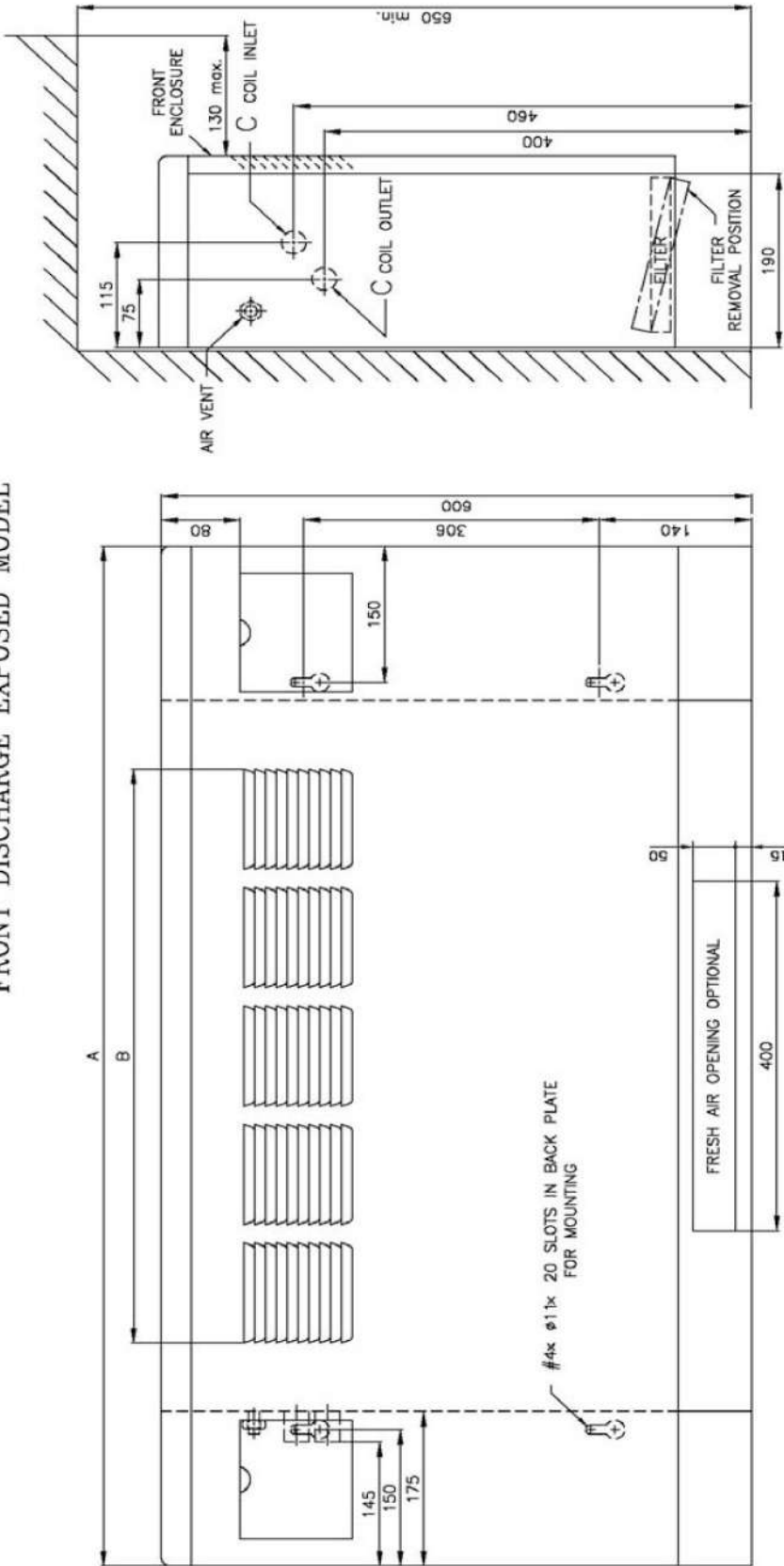

FIGURE 5. THE COIL PRESSURE DROP

ROUGHING IN DIMENSIONS

FRONT DISCHARGE EXPOSED MODEL



Note:

- Suffix 'L' on model no. denotes basic unit with left end (standard) coil connections as shown:
Suffix 'R' on model no. denotes basic unit with right end coil connections.
Unless the change is indicated the Fan-Coil is supplied with the standard left end coil connections.
- All dimensions in mm unless otherwise specified.

MODEL NO.	A	B	C
SF - FE - 02L	920	510	1/2"
SF - FE - 03L	1120	640	1/2"
SF - FE - 04L	1220	780	1/2"
SF - FE - 06L	1360	910	3/4"
SF - FE - 08L	1620	1180	3/4"
SF - FE - 10L	1920	1440	3/4"
SF - FE - 12L	2270	1840	3/4"

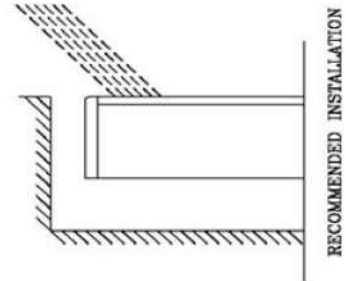

ROUGHING IN DIMENSIONS

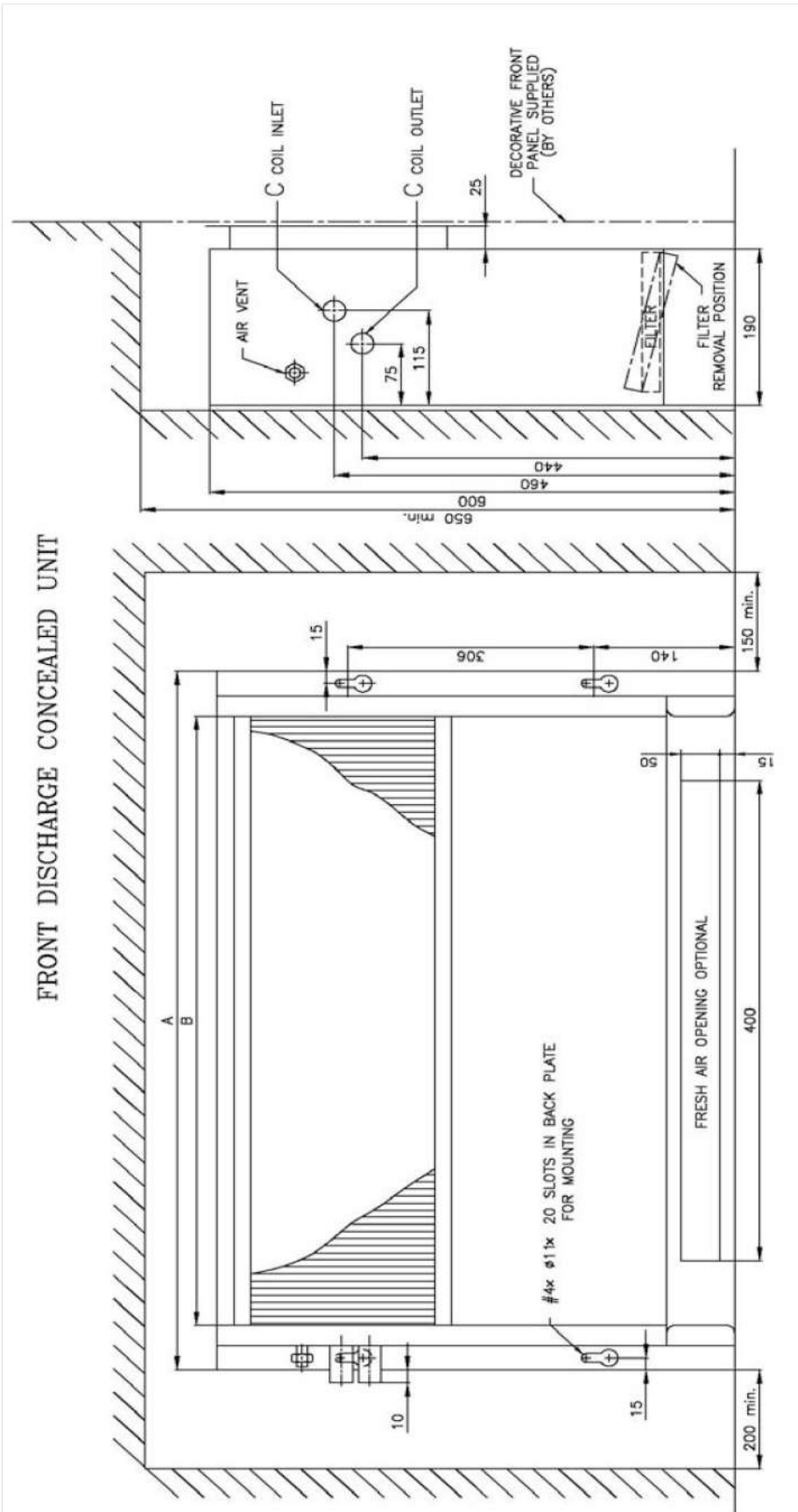

MODEL NO.	A	B	C
SF - FC - 02L	650	570	1/2"
SF - FC - 03L	850	770	1/2"
SF - FC - 04L	950	870	1/2"
SF - FC - 06L	1090	1010	3/4"
SF - FC - 08L	1350	1270	3/4"
SF - FC - 10L	1650	1570	3/4"
SF - FC - 12L	2000	1920	3/4"

ROUGHING IN DIMENSIONS

TOP DISCHARGE EXPOSED MODEL

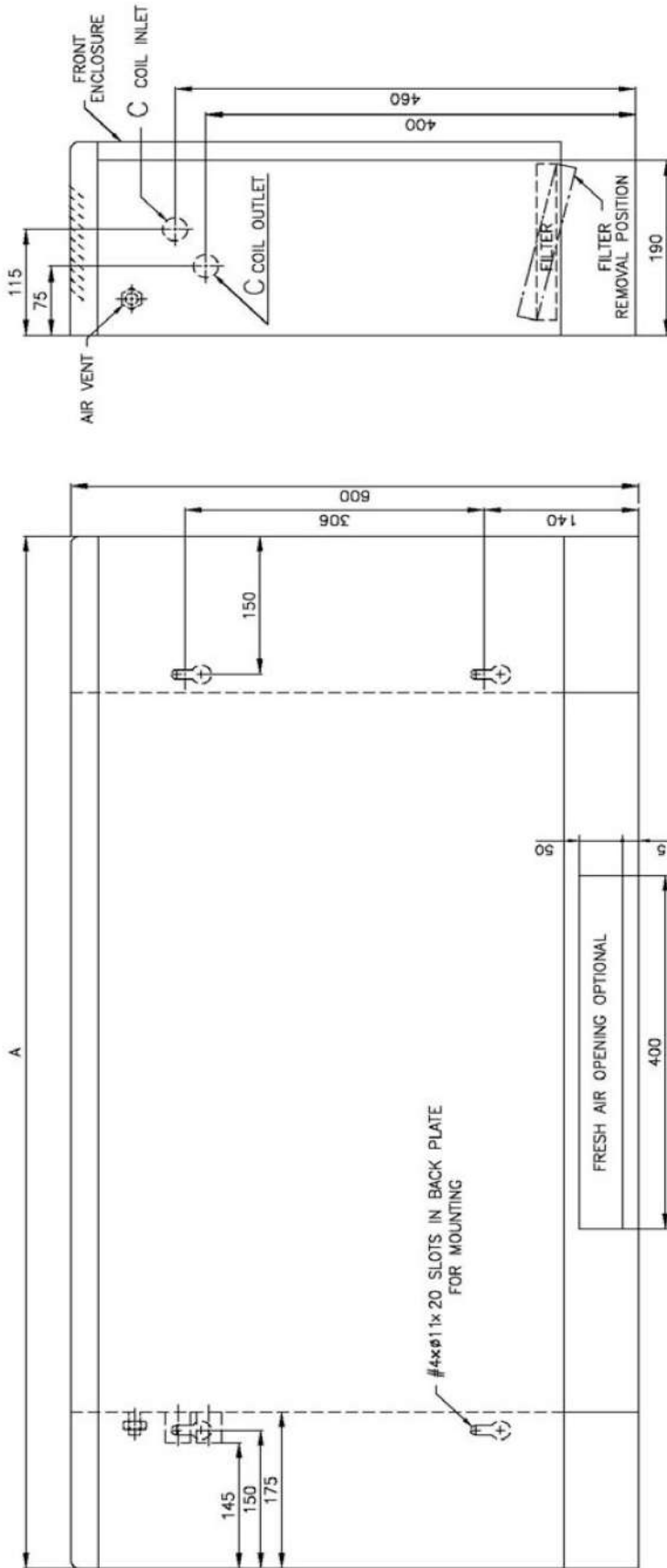

MODEL NO.	A	B	C
SF - TE - 02L	920	510	1/2"
SF - TE - 03L	1120	640	1/2"
SF - TE - 04L	1220	780	1/2"
SF - TE - 06L	1360	910	3/4"
SF - TE - 08L	1620	1180	3/4"
SF - TE - 10L	1920	1440	3/4"
SF - TE - 12L	2270	1840	3/4"

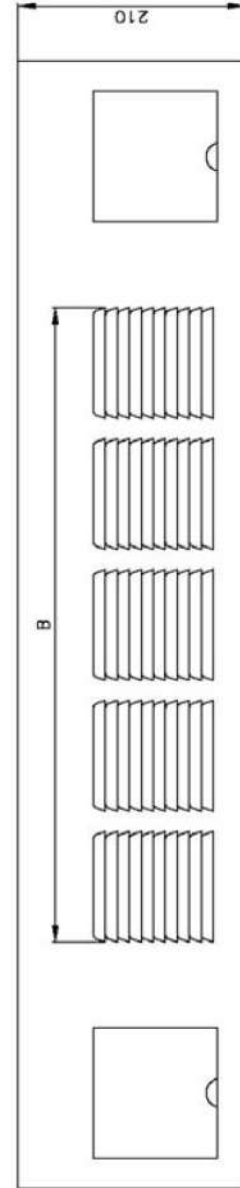

- Note:
- Suffix 'L' on model no. denotes basic unit with left end (standard) coil connections as shown;
Suffix 'R' on model no. denotes basic unit with right end coil connections.
Unless the change is indicated the Fan-Coil is supplied with the standard left end coil connections.
 - All dimensions in mm unless otherwise specified.

ROUGHING IN DIMENSIONS

LO-BOY MODEL

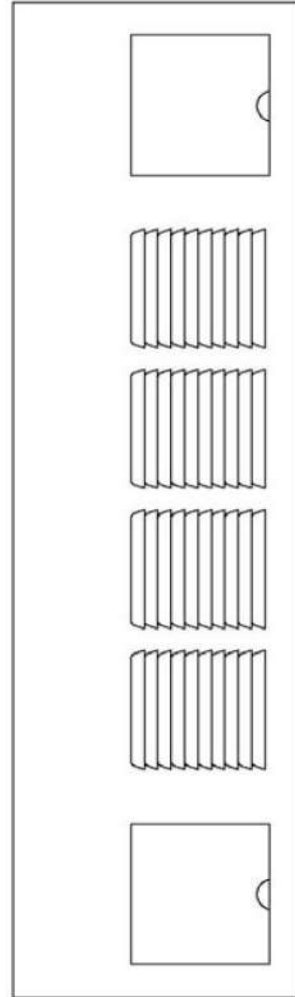
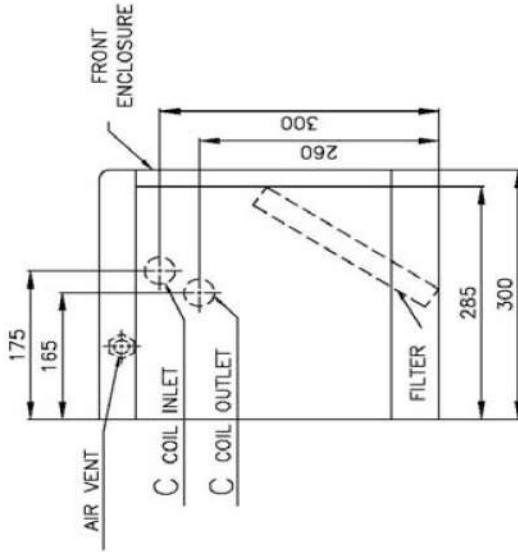
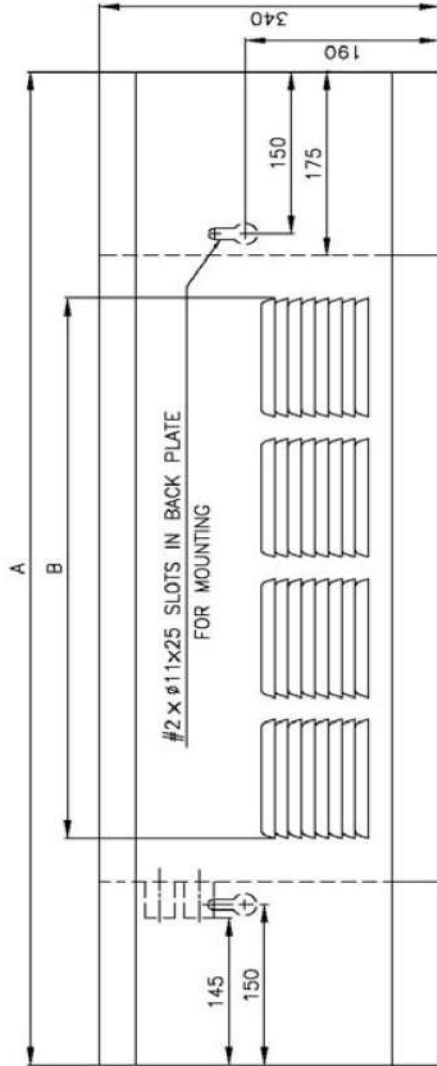

MODEL NO.	A	B	C
SF - TB - 02L	920	510	1/2"
SF - TB - 03L	1120	640	1/2"
SF - TB - 04L	1220	780	1/2"
SF - TB - 06L	1360	910	3/4"
SF - TB - 08L	1620	1180	3/4"
SF - TB - 10L	1920	1440	3/4"
SF - TB - 12L	2270	1840	3/4"

ROUGHING IN DIMENSIONS

CEILING HORIZONTAL CONCEALED MODEL WITH FILTER

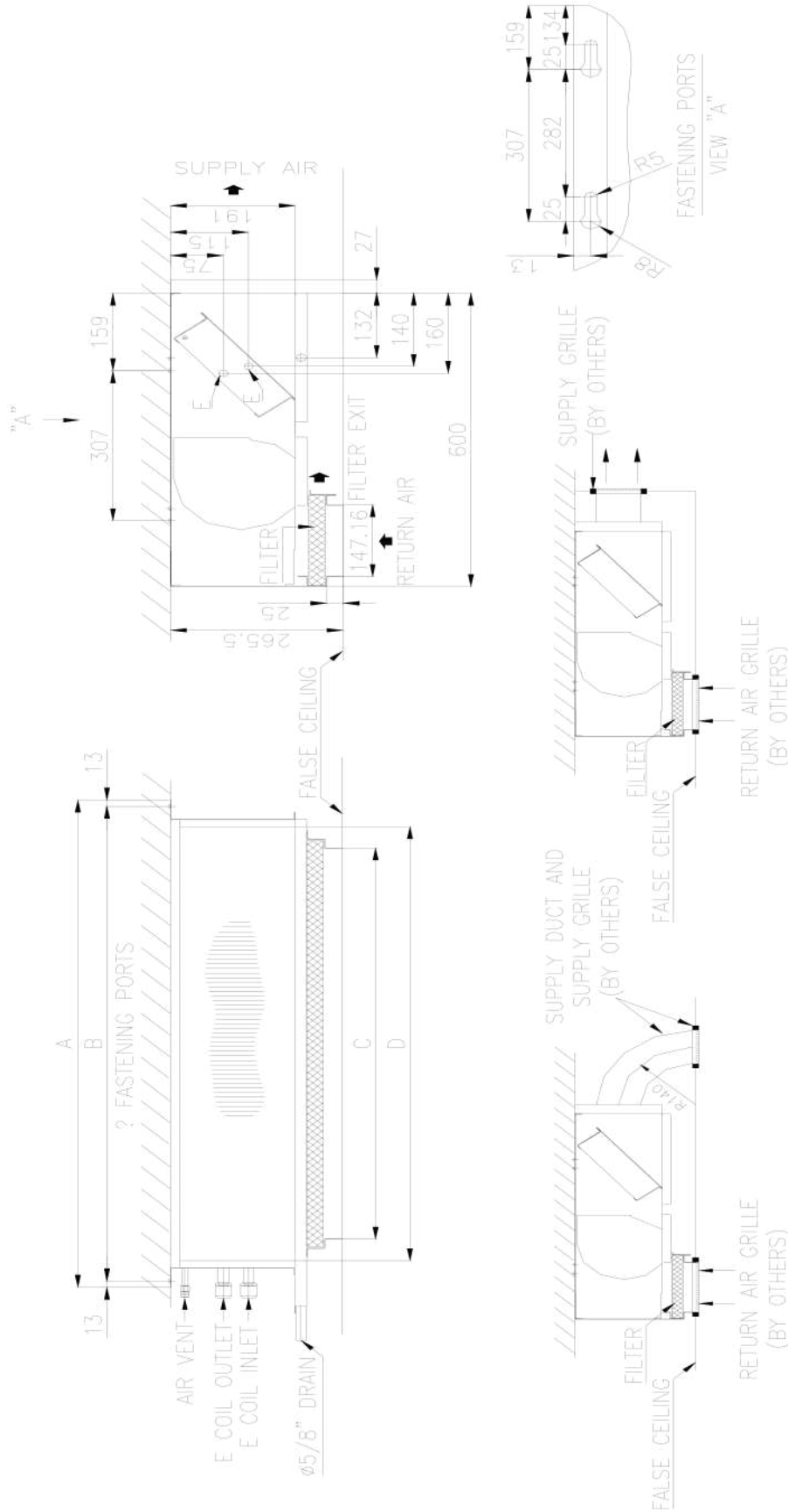

RECOMMENDED TYPES OF INSTALLATION DETAILS

SF-HC	02L	03L	04L	06L	08L	10L	12L
A	650	850	950	1050	1350	1650	2000
B	624	824	924	1064	1324	1624	1974
C	530	730	830	970	1230	1530	1880
D	543	743	843	983	1243	1543	1893
E	1/2"	1/2"	1/2"	3/4"	3/4"	3/4"	3/4"

NOTE:

- SUFFIX "L" ON MODEL NO. DENOTES BASIC UNIT WITH LEFT END. (STANDARD) COIL CONNECTIONS AS SHOWN: SUFFIX "R" ON MODEL NO. DENOTES BASIC UNIT WITH RIGHT END COIL CONNECTIONS AS: UNLESS THE CHANGE IS INDICATED THE FAN-COIL IS SUPPLIED WITH THE STANDARD LEFT END COIL CONNECTION.
- ALL DIMENSIONS MM UNLESS OTHERWISE SPECIFIED.

ROUGHING IN DIMENSIONS

EXPOSED CEILING MOUNTED MODEL

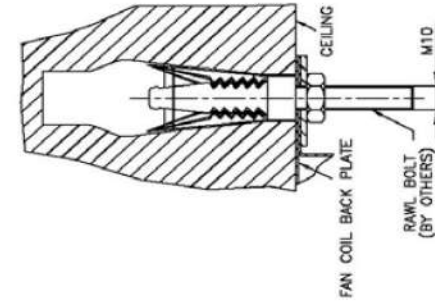
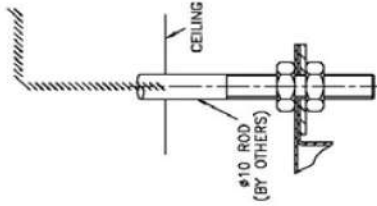
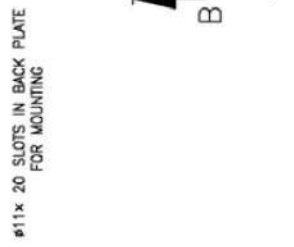
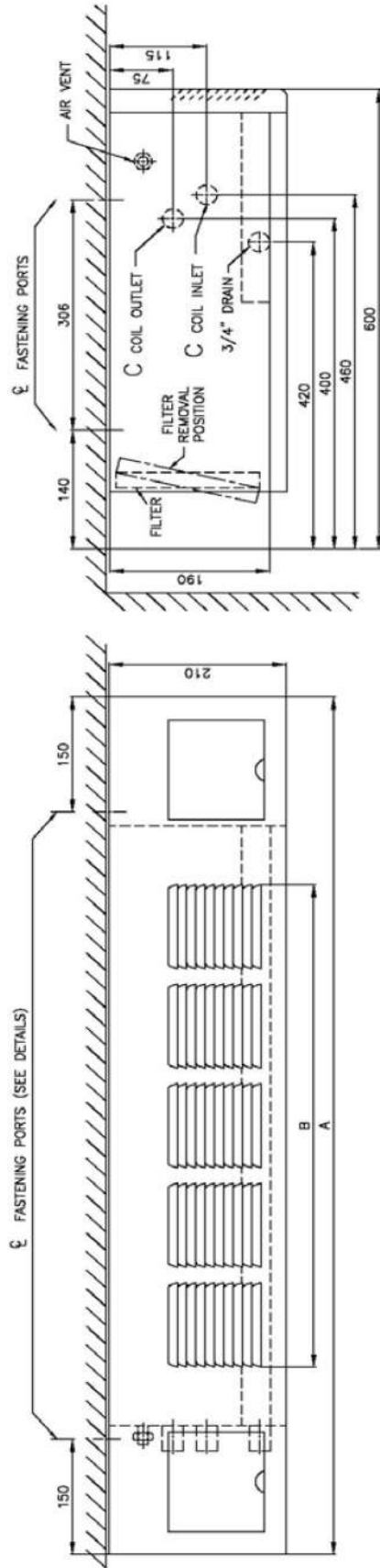

MODEL NO.	A	B	C
SF - HE - 02L	920	510	1/2"
SF - HE - 03L	1120	640	1/2"
SF - HE - 04L	1220	780	1/2"
SF - HE - 06L	1360	910	3/4"
SF - HE - 08L	1620	1180	3/4"
SF - HE - 10L	1920	1440	3/4"
SF - HE - 12L	2270	1840	3/4"

OPTION 2

OPTION 1

SECTION B-B
SUSPENDED FASTENING DETAILS



ENGINEERING SPECIFICATION

25

GENERAL

Furnish and install standard *SARAVEL* fan-coil units based on the given schedule and as shown on the plan drawings. The standard units shall consist of a coil, motor-fan, manual three speed fan switch, fan support, coil condensate drain pan, cleanable air filter, manually operated fresh air damper (optional), and the enclosure.

COIL

All coil performances shall be rated according to ARI 410-91 standard.

All coils shall be three rows deep, eight tubes high, and 14 fins per inch of length. All tubes shall be 3/8 inch O.D. copper tubing with minimum wall thickness of 0.016 inch (0.40mm).

The plate fins shall be of continuous figurate plate type with self spacing collar, die formed from aluminum strips.

The coil shall be designed for a maximum working pressure of 300 psig and pressure tested to 300 psig according to 15-ASHRAE Standard.

CONDENSATE PAN

The condensate pan shall be of 2 mm thick galvanized sheet metal with coating of bitumen. The condensate pan shall easily slide out and equipped with 'S' shaped 19 mm I.D. rubber hose for condensate drain line.

MOTOR

The motors shall be shaded pole split capacitor 4 poles, designed for 220 volts, 50 cycles and 1 phase operations.

The motor shall be suitably cooled by the filtered air; all motors shall start at high speed and shall be capable of operation at three levels of speed. All motors shall have precision mount shafts with large oil reservoirs and self aligning sintered bearings or permanently lubricated ball bearing. Thermo setting varnish shall be baked into wound in-place coils, providing a vibration-free winding. The units shall have rubber mounted base support providing vibration isolation.

FAN

The fan wheel shall be of the forward curved blade type and all aluminum construction. The fan wheel shall be statically and dynamically balanced, mounted directly on the motor shaft. The condensate pan shall also be used as the fan deck; the fan housing shall be of 0.5 mm galvanized steel.

ENCLOSURE

The enclosure shall be of 1.25 mm thick steel sheet to provide rigid structure. It shall be rust proofed, phosphate, and furnished with a baked enamel finish. The inside of the front panel shall be lined with 10 mm thick polyethylene insulation.

AIR FILTER

The fan-coil units shall be equipped with 1 inch thick, 4 ply aluminum mesh filter, easily removable and washable.

FRESH AIR DAMPER

The fresh air dampers shall be supplied as an optional item with each fan-coil. The dampers shall be adjustable from the top of the units.

FAN SWITCH

Except HC models a three speed manual fan switch shall control the fan speed. On the vertical and Lo-Boy units the switch shall be factory mounted on the unit, either on the left or right of the unit per customer's instructions. On other units the switch shall be delivered loose for mounting on the wall.